

Custom Processing On FPGA

“Have it your way”

- Xilinx Embedded Solutions
 - PicoBlaze, MicroBlaze, PowerPC 405
 - Use only the peripherals and configurations you want
 - No NRE or expensive EDA tools
 - Avoid obsolescence
- MicroBlaze - Custom Processing Made Easy
 - Pre-built, ready to use configuration options
 - Match the processor to the application
 - Platform Studio – tools customized along with the processor
- Introducing MicroBlaze v4.00
 - Floating point
 - Increased performance
 - Lower cost



MicroBlaze Processor Flexibility

- Ready to Use, Pre-Built Configuration Options
- MicroBlaze Key Features
 - 32-bit Harvard Bus RISC Architecture
 - 32 General Purpose Registers
 - Instruction and Data Caches
 - 32-bit Barrel Shifter
 - Hardware Divider
 - Fast Simplex Link FIFO Channels for Easy Direct Access to Fabric and Hardware Acceleration
 - Hardware Debug Module
- Easy-to-use Development Environment
 - Xilinx Platform Tool Suite in the Embedded Development Kit
- Third Party RTOS Support

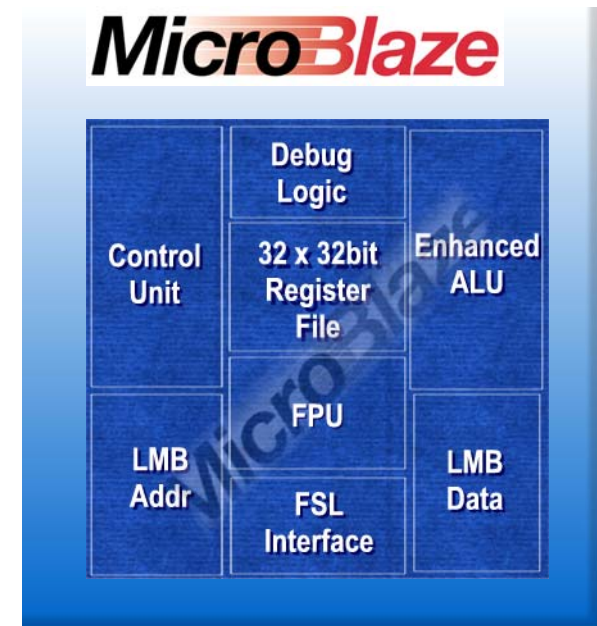

MicroBlaze System Flexibility

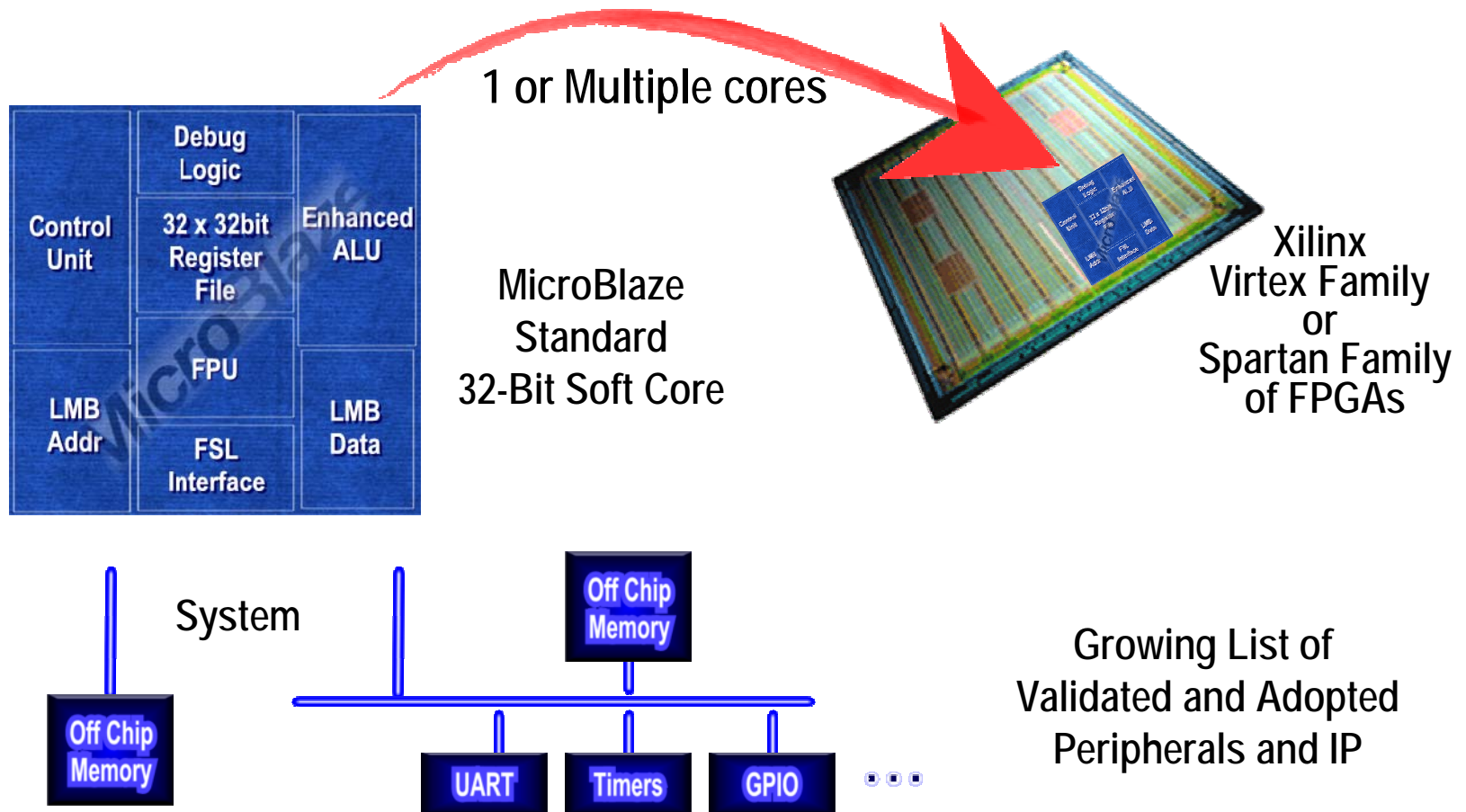

What's New for MicroBlaze?

- Backward compatible with MicroBlaze v3.00
- Better performance
 - Higher maximum clock frequency and fewer cycles per instruction (CPI)
- Tightly-coupled Floating-point unit (FPU)
 - IEEE754-compatible, single-precision floating point
 - FP instructions part of MicroBlaze instruction set
 - Fully supported by compiler, tools, and instruction-set simulator (ISS)
- Pattern-compare instructions for optimized comparisons
- Extending configuration flexibility
 - Configurable hardware multiplier
 - Floating point is a selectable option
- Enhanced debug logic for faster download

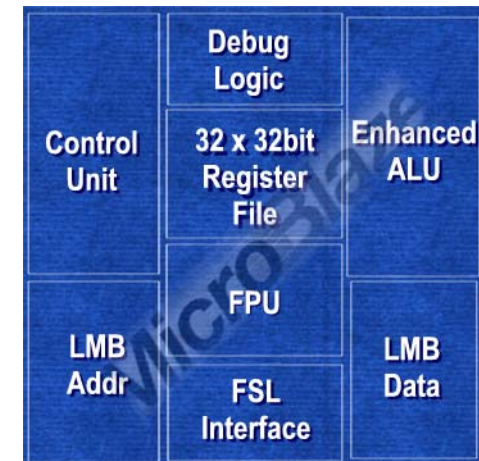

MicroBlaze Target Devices

- MicroBlaze is a soft processor core that can be implemented in the Virtex and Spartan family of FPGAs



MicroBlaze Architecture

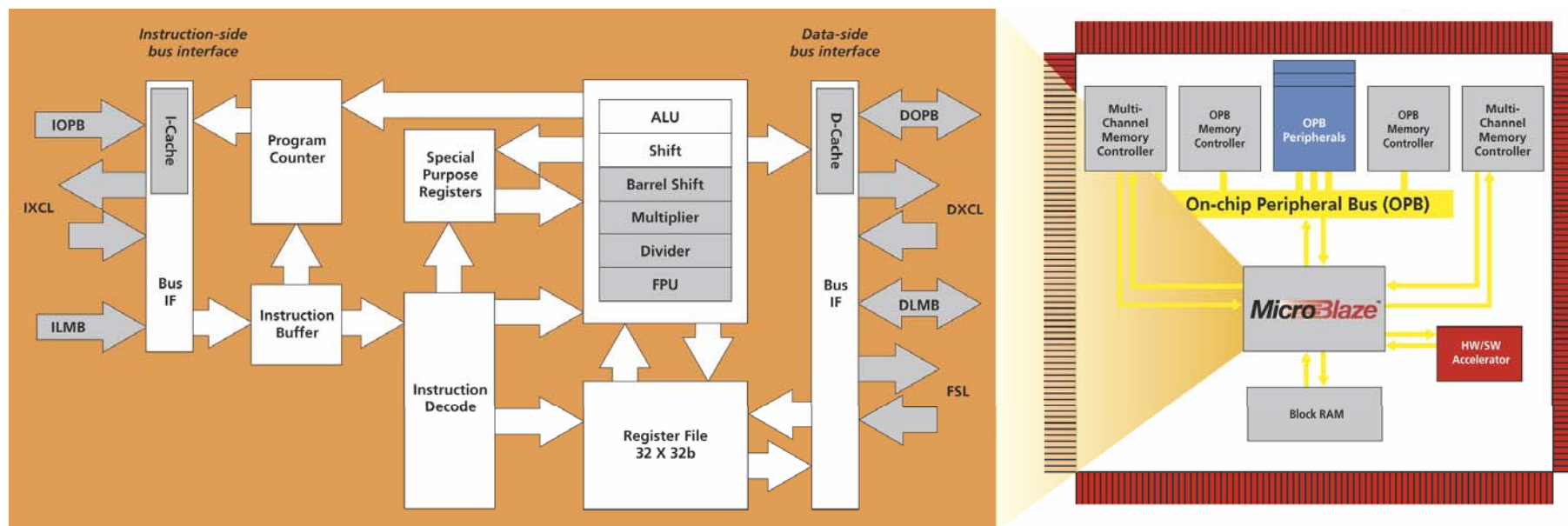

Basic Processor Functions
 Configurable Functions
 Designer Defined Blocks
 Peripherals – Xilinx or 3rd Party or Designer Defined

IXCL_M – Instruction side Xilinx Cache Link Master
 IXCL_S – Instruction side Xilinx Cache Link Slave
 DXCL_M – Data side Xilinx Cache Link Master
 DXCL_S – Data side Xilinx Cache Link Slave
 MFSL – Master Fast Simplex Link
 SFSL – Slave Fast Simplex Link

IOPB – Instruction side On-chip Peripheral Bus
 DOPB – Data side On-chip Peripheral Bus
 ILMB – Instruction side Local Memory Bus
 DLMB – Data side Local Memory Bus
 Bus IF – Bus Interface

Tightly Integrated FPU

- Matched maximum clock frequency
 - FPU, MicroBlaze pipeline run at the same frequency
- Low latency
 - FP operands use native CPU registers
 - FP instructions directly integrated in data flow
- Optimum resource utilization
 - Reuse already existing pipeline resources
 - FPU adds just 1,000 LUTs to MicroBlaze

Optimized for cost and performance

FPU Highlights



FPGA	Size (MicroBlaze + FPU)	Maximum Clock Frequency	Peak Floating-Point Throughput
Virtex-4	~2000 LUTs (1,002 FPU + 988 MB)	200 MHz	33 MFLOPS

Main Hardware Configuration Options

Barrel Shifter <input type="radio"/>	HW Multiplier <input type="radio"/>	Cache Link <input type="radio"/>
Pattern Compare <input type="radio"/>	HW Exception <input type="radio"/>	I and D Cache <input type="radio"/>
Divide <input type="radio"/>	FPU <input checked="" type="radio"/>	Debug Logic <input type="radio"/>

Frequency Optimized Subsystem		
Local Instruction Memory	Local Data Memory	Peripherals
8KB Block RAM	8KB Block RAM	GPIO



Complete FP Support

- Loads/stores use standard MicroBlaze instructions
 - Infinity, signed zeros follow IEEE-754 conventions
 - Software libraries for additional FPU operations
 - Rounding
 - Square root
 - Conversions
 - Other floating-point library functions
- => FPU operations seamlessly supported by standard programming model

MicroBlaze v4.00 Debug Logic

- New debug logic
 - Inserts instructions into the pipeline
 - Access to anything that instructions can access
 - Packetized data-transfer protocol
- Immediate value to users:
 - Less debug logic — reduced by 50%
 - Faster download — up to 15x faster
 - Access to all registers, including ESR, EAR, and FSR

New Pattern-Compare Instructions

- Efficient methods to compare words
 - Complement existing compare-and-branch instructions
- Example applications
 - String comparisons
 - Pattern searches
 - Multimedia applications

Instruction	Description
pcmpbf	Pattern-compare byte find
pcmpeq	Pattern-compare equal
pcmpne	Pattern-compare not equal

Performance Improvements Bringing It All Together

- Now supporting GCC 3.4.1 unit-at-a-time compile
 - Moved up from GCC 2.9 function-at-a-time compile
 - New hardware and compiler boost performance
 - 0.79 DMIPS/MHz to 0.92 DMIPS/MHz
- => Overall performance benefits to users:
- 16% performance improvement on integer code
 - Up to 40% faster string searches
 - Up to 120x performance improvement on FP code

Configured for Performance



FPGA	Size	Clock Frequency	Dhrystone 2.1	Performance
Virtex-4 (4VLX25-12)	1,269 LUTs	180 MHz	166 DMIPS	0.92 DMIPS/MHz
Virtex-II Pro (2VP20-7)	1,225 LUTs	150 MHz	138 DMIPS	0.92 DMIPS/MHz
Spartan-3 (3S1500-5)	1,318 LUTs	100 MHz	92 DMIPS	0.92 DMIPS/MHz

Main Hardware Configuration Options

Barrel Shifter <input checked="" type="radio"/>	HW Multiplier <input checked="" type="radio"/>	Cache Link <input type="radio"/>
Pattern Compare <input checked="" type="radio"/>	HW Exception <input type="radio"/>	I and D Cache <input type="radio"/>
Divide <input type="radio"/>	FPU <input type="radio"/>	Debug Logic <input type="radio"/>

Performance Optimized Subsystem		
Local Instruction Memory	Local Data Memory	Peripherals
8KB Block RAM	16KB Block RAM	GPIO, Timer



Configured for Frequency



FPGA	Size	Clock Frequency
Virtex-4 (4VLX40-12)	988 LUTs	205 MHz
Virtex-II Pro (2VP20-7)	827 LUTs	170 MHz
Spartan-3 (3S1500-5)	983 LUTs	105 MHz

Main Hardware Configuration Options

Barrel Shifter <input type="radio"/>	HW Multiplier <input type="radio"/>	Cache Link <input type="radio"/>
Pattern Compare <input type="radio"/>	HW Exception <input type="radio"/>	I and D Cache <input type="radio"/>
Divide <input type="radio"/>	FPU <input type="radio"/>	Debug Logic <input type="radio"/>

Frequency Optimized Subsystem		
Local Instruction Memory	Local Data Memory	Peripherals
8KB Block RAM	8KB Block RAM	GPIO

MicroBlaze in Spartan-3E FPGAs

Delivering Soft Processor for Less than 50 Cents



- Customization and Flexibility
 - Rich expanding peripheral set
 - Custom peripheral support
- No Obsolescence
 - MicroBlaze source code available
- More User I/Os
- System Integration
 - Reduce cost

Effective cost as low as \$0.48*

* Based on pricing for XC3S100E in 2005, 250K units



Embedded Development Kit

Accelerate Programmable System Design

- Define MicroBlaze Based Systems
 - Implement systems that interface to programmable logic
 - EDK includes MicroBlaze processor core and peripheral IP
- Complete Hardware and Software Development Environment
 - Platform Studio Technology
 - Generate custom hardware platform
 - Generate Board Support Packages “on-the-fly”
 - ‘C’ development using GNU Compiler, ‘C’ Libraries
 - Platform Debug Technology
 - Debug hardware using Xilinx Chipscope Pro bus analyzer
 - Debug software with GDB and Xilinx Debug Engine (XMD)
 - Utilize complete reference and application examples to speed development



Easy Development Tool Support

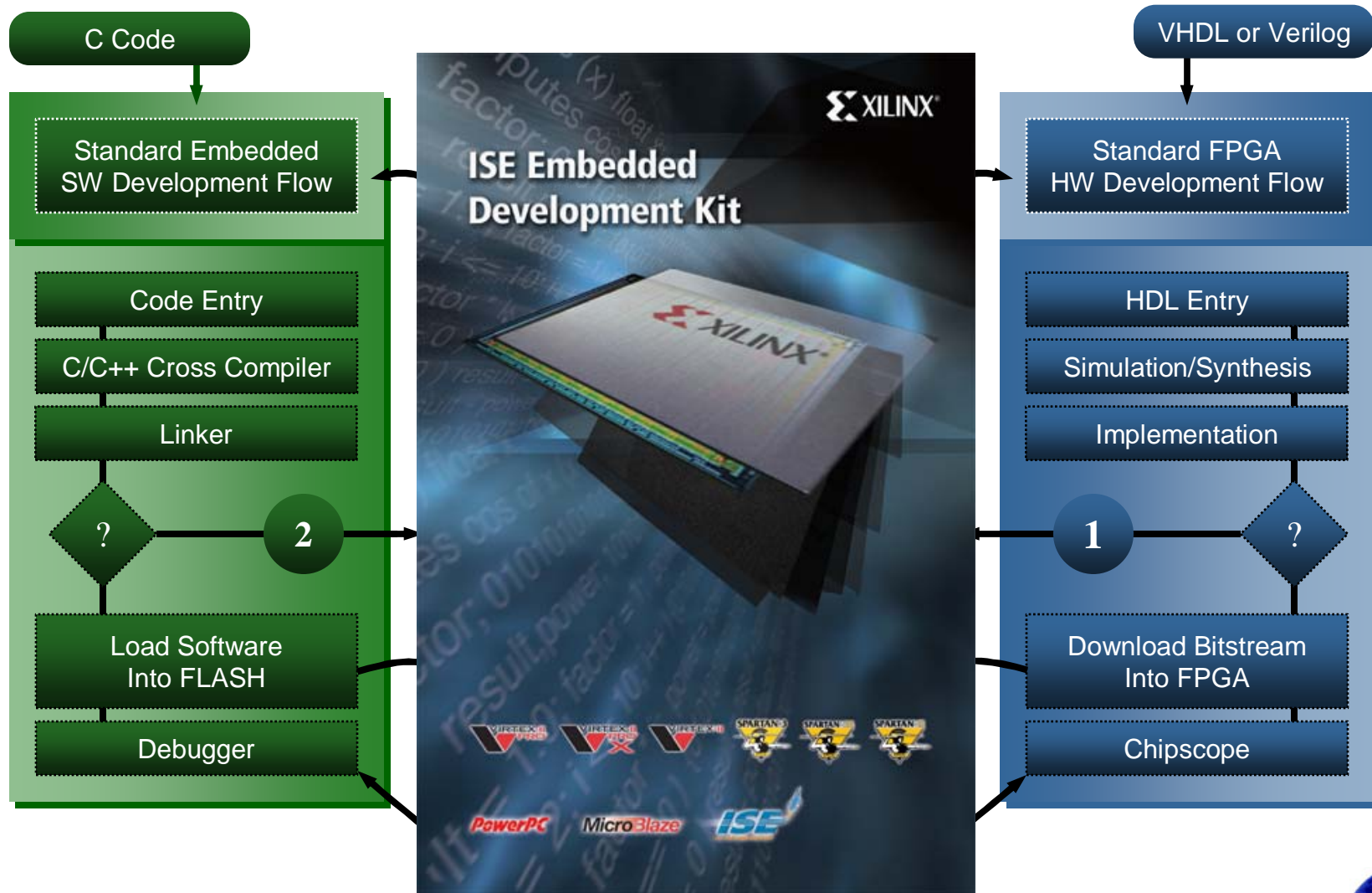

60+ Peripheral IP for MicroBlaze

Bus, Bridge and Arbiter Infrastructure

- OPB (On-chip Peripheral Bus)
- OPB PCI Arbiter
- OPB to OPB Bridge
- OPB Arbiter
- FSL Bus (Fast Simplex Link)
- LMB (Local Memory Bus)
- OPB IPIF

Memory Interface Cores

- LMB BRAM Interface Controller
- OPB External Memory Controller
- OPB SDRAM Controller
- OPB DDR SDRAM Controller
- OPB BRAM Interface Controller
- OPB System ACE Interface Controller
- Data Side BRAM Interface Controller
- Instruction Side BRAM Interface Controller

Peripherals

- OPB Interrupt Controller
- OPB 16450/16550 UART
- OPB UART Lite
- OPB IIC
- OPB SPI
- OPB PCI
- OPB Ethernet (EMAC)
- OPB Ethernet Lite (EMAC Lite)
- OPB ATMC
- OPB Single Channel HDLC
- OPB Multi Channel HDLC
- OPB Timer
- OPB Timebase WDT (Watchdog Timer)
- OPB GPIO
- OPB Central DMA Controller

...And More!



MicroBlaze RTOS & Software Development Tools

Xilinx Tools

XMK

Xilinx MicroKernel

- Small, Modular micro kernel
- POSIX thread compliant, small footprint
- Networking, filesystem libraries



GNU C/C++ Compiler tools



GDB Debugger

XMD

Xilinx Microprocessor Debugger

- Backend Debug engine for GDB
- JTAG-based on-chip debug
- Instruction Set Simulator

lwIP

Light Weight IP

3rd Party Tools



Nucleus



ThreadX



μC/OS-II



μCLinux



μITRON



Seehau Debugger



Processor Use Models

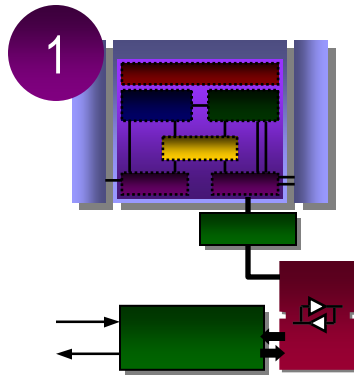

State Machine

- Lowest Cost, No Peripherals, No RTOS & No Bus Structures
- VGA & LCD Controllers
- Low/High Performance

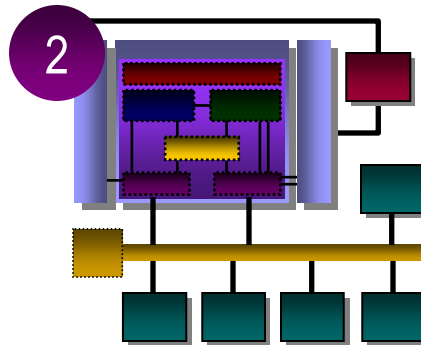

Microcontroller

- Medium Cost, Some Peripherals, Possible RTOS & Bus Structures
- Control & Instrumentation
- Moderate Performance

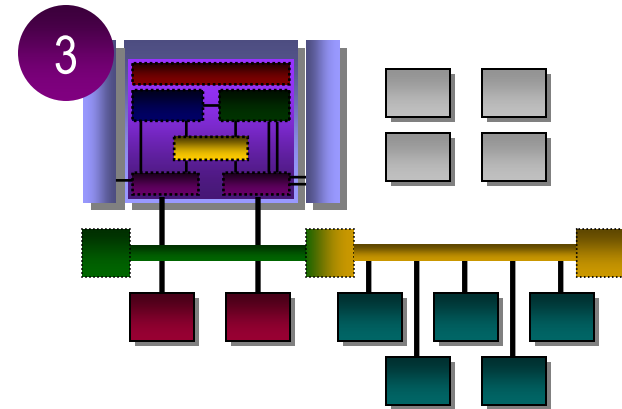

Custom Embedded

- Highest Integration, Extensive Peripherals, RTOS & Bus Structures
- Networking & Wireless
- High Performance



Range of Use Models

Case Study – Use Model 2

- Multi-Loop Industrial Control System
 - Low Cost Spartan-3
- Target Function
 - Serve as the Information Collection Hub of the System
- Requirements & Goals
 - Cost Competitive with OTS
 - Support Scalable Systems with a Wide Range of Peripherals
 - Future Proof the Solution & Show Cost Reduction over Time

OTS MCU	µBlaze Based
Fixed solution with limited peripherals	Scalable to accommodate varied peripheral requirements
Obsolescence Concern	Long term product availability
Very few integration opportunities and difficult to customize	FPGA resources allow for further integration and IP customization
Difficult to standardize on one architecture	System flexibility supports a wide range of processor systems

MicroBlaze + Some IP

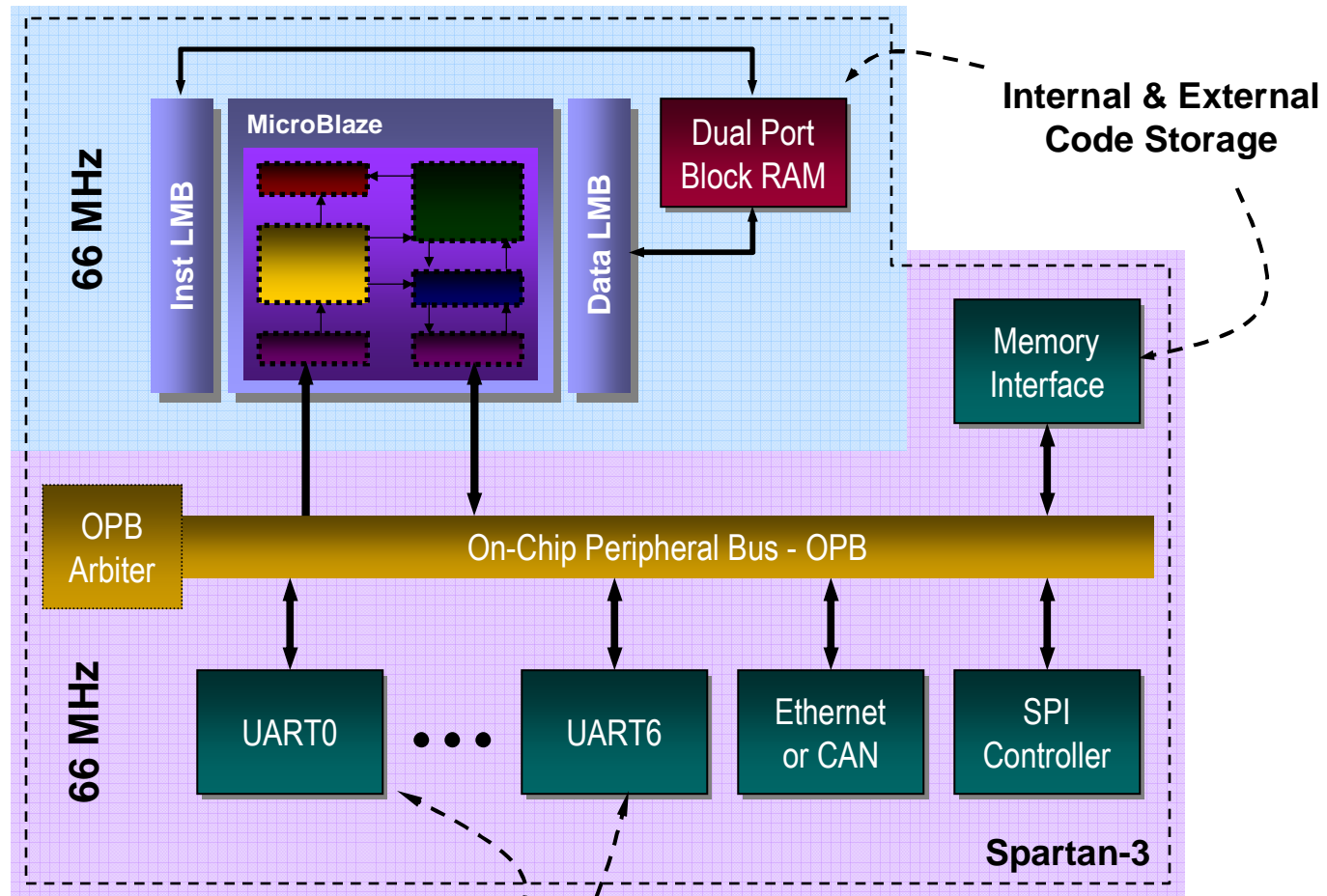

Completely Scalable System Architecture

Xilinx Processor Solutions

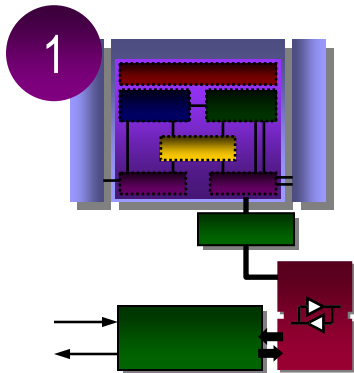

State Machine

PicoBlaze™
MicroBlaze
Ultra Controller™
PowerPC™

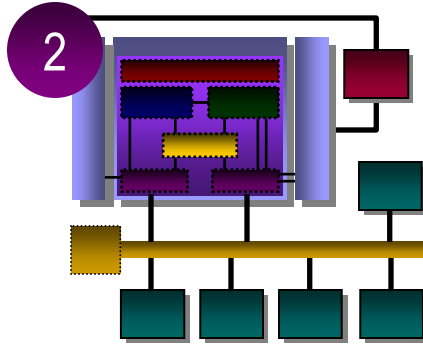

Microcontroller

MicroBlaze
PowerPC™
Ultra Controller™

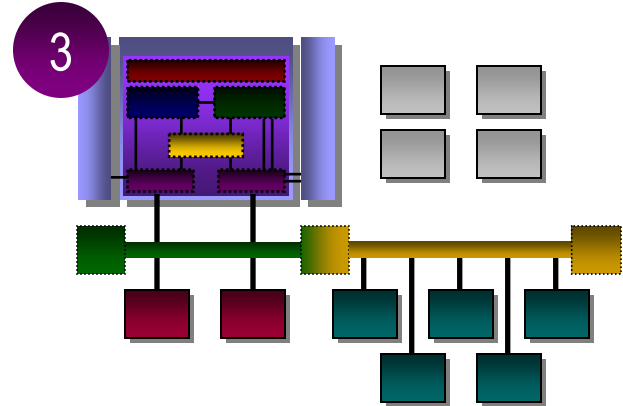

Custom Embedded

PowerPC™
MicroBlaze



Range of Solutions

MicroBlaze Testimonials

- “As the cost of designing and manufacturing custom chips continues to soar, processor cores optimized for FPGAs have the potential to lure designers away from ASICs and SoCs. The newest version of the Xilinx MicroBlaze processor core offers more reasons to use an FPGA, such as higher clock speeds and an optional, tightly-coupled FPU. In embedded applications such as motor control, industrial machine control, multimedia, and office automation, an FPU can make a big difference.” - *Tom R. Halfhill, Sr Analyst of In-Stat's Microprocessor Report*
- “The MicroBlaze processor provides a scalable solution that is fully customizable, area-efficient and can be optimized for our most cost-sensitive designs. The MicroBlaze 4.00 solution with the new FPU delivers even more performance, flexibility and ease of use, so our embedded developers can extend the life cycle of our existing products and bring new products to market even faster.” - *Said Zahrai, Project Manager at ABB*



Comprehensive Embedded Services

- Embedded Systems Development Course (2-day course)
 - Effectively develop, debug, and simulate an embedded system
 - Identify tools used in the EDK
 - Understand the hardware and software flows defined in the EDK
 - Understand the hardware and software simulation environments
 - Integrate custom IP into the EDK
- On-Site Xilinx Embedded Design Specialist
 - Provides dedicated application engineer to assist in system design, programmable logic design and embedded software development to accelerate product development
 - Deliver optimal embedded design solution for customers
- Award-winning Technical Support
 - Customer Hotline Support
 - MySupport.xilinx.com
 - Embedded Processor Forum and Tech Tips



EDUCATION SERVICES
Xilinx Global Services



SUPPORT SERVICES
Xilinx Global Services



The Year's Ten Best
Web Support Sites



Summary

- New MicroBlaze v4.00 available now
- Shipped with Xilinx Embedded Development Kit (EDK) 7.1i
- EDK 7.1i — \$495 includes:
 - Platform Studio 7.1i development tools
 - Hardware and software IP support for MicroBlaze and PowerPC 405
 - MicroBlaze v4.00
- No need to be a processor expert
- No ASIC expertise required
- No NRE
- No licensing fee or royalties
- Visit www.xilinx.com/microblaze for more information

Cost, time-to-market, flexibility, and performance

